



**ECO-WORTHY**

An aerial photograph of a farm complex. A large, dark brown wooden barn with a red-tiled roof has several solar panels mounted on its side. In the foreground, there is a smaller blue structure with solar panels on its roof. The surrounding area includes green grass, a paved area, and some trees. A green diagonal bar is overlaid on the top right and bottom right of the image.

# 3900W Solar Power System Manual

Tel: +44 20 7570 0328(EU)  
1-866-939-8222(US)

E-mail: [customer.service@eco-worthy.com](mailto:customer.service@eco-worthy.com) Web: [www.eco-worthy.com](http://www.eco-worthy.com)

# Contents

---

1. Safety Caution.....	1
2. Product Overview .....	2
3. Components Description.....	3
4. Installation Guide.....	6
5. Fusing and Setting .....	15
6. Testing and Troubleshooting.....	16
7. Maintenance.....	18
8. Support .....	19

## Safety Caution

Working with and installing electrical equipment is dangerous. Potential risks include hazards, electrocution and electrical fires.

Solar panels generate electricity as soon as being exposed in sunlight. To avoid a shock hazard, it's better to keep the panel covered with something during installation and avoid direct contact with the output terminals.

- Observe correct polarity with all interconnections between the solar-panel, charge controller, and the battery. Reverse polarity may causedamage
- Make sure all wire connections are tight and secure, loose connections may cause sparks and intermittent behavior
- Do not perform installation in the presence of any flammable materials
- Make sure you work in a well-ventilated area
- Use properly insulated tools: adjustable wrench, wire stripper, screw-driver, wire crimping tool, insulation gloves
- Remove metal items such as rings, bracelets, and watches

# Product Overview

ECO-WORTHY 3900W Off-Grid Solar Power System, an electricity supply project, which is clean, quiet, and compatible with shed and house roof.

## The complete kit contains:

- 20pc 12v 195W Monocrystalline Solar Panels
- 1pc 3500W 48V Hybrid Inverter
- 8pcs 12v 100Ah Lithium Batteries
- 1pc 48V Battery Charging Balancer
- 1pc 6 String PV Combiner Box
- 4 pairs of 16.4ft 11AWG Solar Extension Cable
- 1pc 16ft 8AWG Solar-Controller Cable
- 4 pairs of 1ft 10AWG Lithium Battery Cable
- 1 pair of 4.9ft 5AWG Battery-Inverter Cable
- 20 set of Z-Bracket
- Necessary bolts and nuts designed for plane installation.

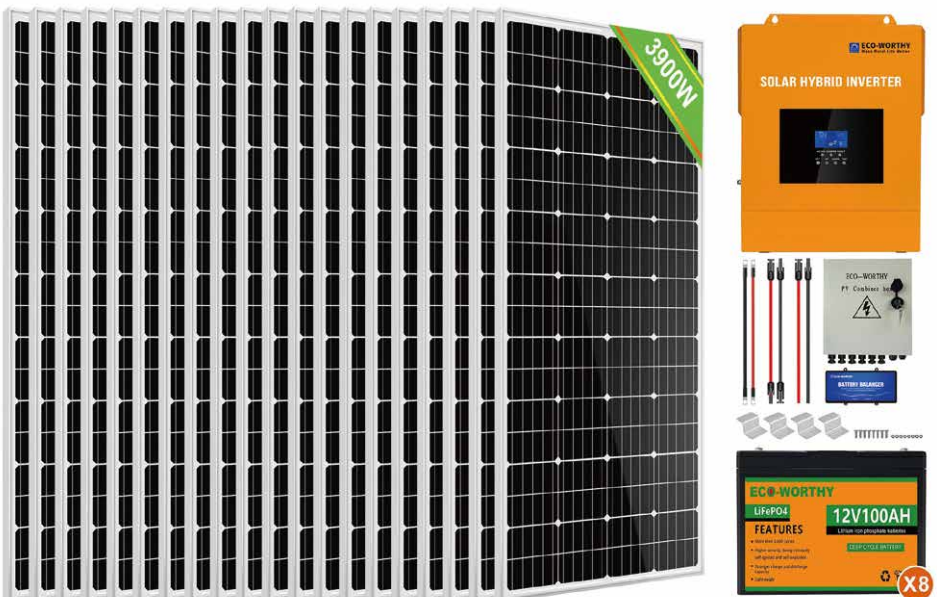

# Components Description

## Solar Panel

The solar panel is a set of solar photovoltaic modules that generate electricity based on sunlight. This system contains 20 pieces of 195W panels with monocrystalline solar cells.

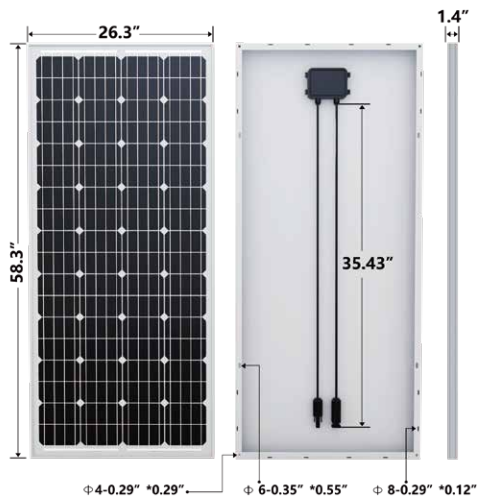

Electrical Data	
Maximum Power at STC <sup>o</sup>	195W
Optimum Operating Voltage (Vmp)	19V
Optimum Operating Current (Imp)	10.27A
Open Circuit Voltage (Voc)	22.8V
Short Circuit Voltage (Isc)	12.28A
Module Efficiency	19.41%
Maximum System Voltage	1000v
Maximum Series Fuse Rating	8-10A

Junction Box	
IP Rating	IP68
Diode Type	blocking bypass diodes
Output Cables	12AWG (2.9 ft long)

Solar Cable Connectors	
Rated Current	30A
Maximum Voltage	1000V
Maximum AWG Size Range	10AWG ~ 14AWG
Temperature Range	-40 C ~ +85 C
IP Rating	IP67

## All-in-One Inverter

The hybrid unit combines a 80A MPPT solar charger controller and a 3500W 48VDC - 110/120VAC pure-sine-wave inverter. With bypass function, it can be connected to utility power for battery charge, it can also be used as a UPS unit with batteries.



<b>Model Name</b>	HF4835U80-145
<b>Color</b>	White and Black
<b>Operating Temperature Range</b>	-10-55°C
<b>IP Grade</b>	IP20
<b>Safety Class</b>	I
<b>AC Output:</b>	
<b>Rated Power</b>	3500VA/3500W
<b>Voltage</b>	120Vac±5%
<b>Rated Current</b>	29A
<b>Battery Input:</b>	
<b>Voltage Range</b>	40-60VDC
<b>Rated Voltage</b>	48VDC
<b>AC Input:</b>	
<b>Voltage Range</b>	90-140VAC
<b>Frequency</b>	50 Hz/60 Hz
<b>Max. AC Bypass Current</b>	40A
<b>Max. AC Charge Current</b>	40A
<b>PV Input:</b>	
<b>Max. Power</b>	4400W
<b>Max. Open Voltage</b>	145V
<b>MPPT Input Voltage Range</b>	60-115VDC
<b>Max. Input Current</b>	50A
<b>PV Output:</b>	
<b>Max. Power</b>	4200W
<b>Max. Charge Current</b>	80A

## Batteries

The complete system includes 8 12V 100Ah rechargeable lithium batteries. For this is a 48V system, the batteries should be wired as a 48V battery bank. The total capacity of the battery bank is about 9600Wh.

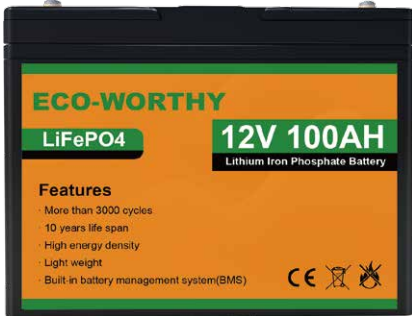

12V 100Ah LiFePO4 Battery	
Battery Capacity	100ah
Battery Power	1200W-h
Battery Voltage	12V
Maximum Charge/ Discharge Current	80A/100A
Charge Temperature Range	0-55 C
Discharge Temperature Range	-20 –55 C
Maximum Charge Voltage	14.5V
Discharge Cut-Off Voltage	10V
Screw size	M8
Battery Size	260*168*209mm (10.2*6.6*8.2inch)
Battery Weight	10.2kg/22.4lbs

## Combiner Box

The 6 string combiner box is designed for orderly arranging those wires from the solar panels array. In such a big system, there usually be many cables come from each individual solar panel, to reduce the difficulty of connection and future maintenance, a combiner box is extremely important.

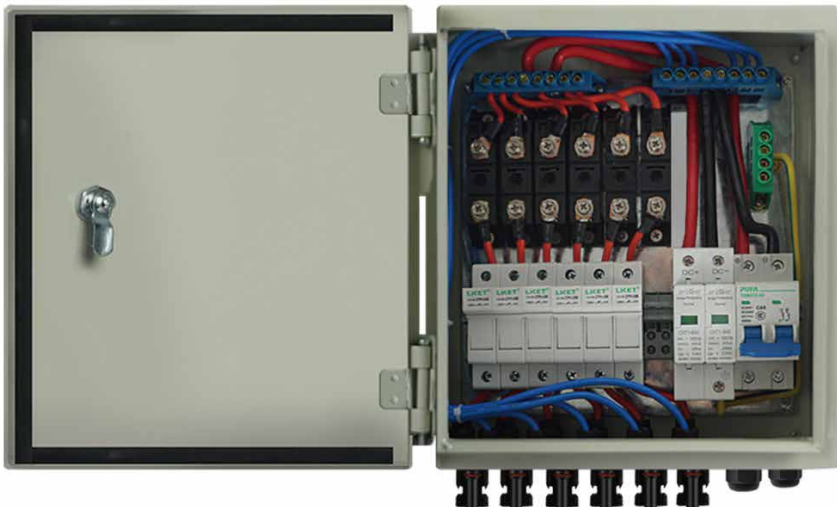

## 16.4ft MC4-MC4 Cable

11 AWG cable with double MC4 connectors for solar array - combiner box connection

## 16.4ft Extension Cable

8 AWG MC4-copper cable for combiner box - inverter connection



16.4ft MC4-MC4 Cable



16.4ft Extension Cable

## Ring Cable



## Inverter Cable

5AWG cable for battery bank - inverter connection



## Z Mounting Brackets

Mounting brackets for fixing panel to a flat surface. There are 4 brackets for each solar panel



# Installation Guide

## -Place the hybrid inverter

The hybrid inverter should be put indoor to avoid raindrop or any other weather issue that may causes electrical fault. Here some notice should be followed:

- Please do not install the hybrid inverter in a humid, greasy, flammable, explosive, dusty or other severe environments.
- During cabinet installation, sufficient space shall be reserved around the hybrid inverter for heat dissipation.
- The polarity of the battery input end of this product shall not be reversed, otherwise the device may be damaged easily or there may be some unpredictable dangers.
- It is required to confirm that the hybrid inverter is the only power supply for the load. It is forbidden to use the machine in parallel with other input AC power to avoid damage.

It can be mounted on wall with proper screws, there are reserved mounting holes on the edge of the unit.

## -Setup the battery bank

The hybrid inverter in this system requires a 48V battery bank for running.

With 8 pieces of batteries, the connection should be:

1. Connect every 2 batteries in parallel to form 4 12V 200Ah battery groups.
2. Connect the 48V battery balancer to the 48V 200Ah battery group by connecting the 4 pairs of wires on the balancer to the positive and negative terminal of each 12V 200Ah battery group



3. Connect the 4 12V 200Ah battery groups in series to form a 48V 200Ah battery group.

The overall diagram as below:

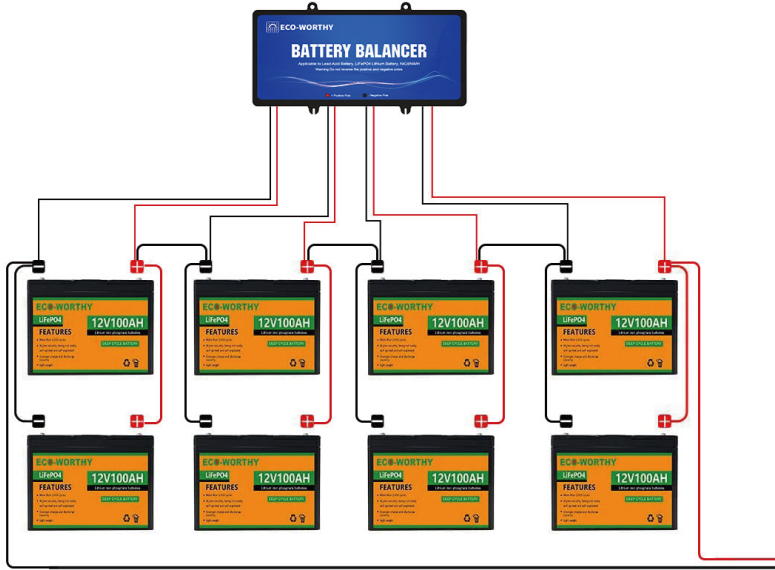

### Connect battery with hybrid inverter

Use the cable inside the inverter package to wire the battery bank to the hybrid inverter. There is one battery port on the bottom of hybrid inverter.



## -Mount the solar panels

Determine a location for the solar panel that is exposed in direct sunlight and clear of any shading such as trees, roof overhangs, etc. Ideally, the panels should be positioned to minimize the wiring distance between the solar panel and the combiner box.

For Northern Hemisphere installations, the solar panels should be mounted at an angle facing true south (true north for Southern Hemisphere installations). The mounting angle should be equal to the latitude location of where you are installing the solar panels. For example, the latitude of Miami, Florida, USA is 25 degrees. Therefore, solar panels installed in this area should ideally be facing true south at a tilt angle of 25 degrees.



When mounting a panel using Z-Brackets, a well-nut (also known as “expansion nut”) is often used on a pre-drilled hole. This procedure safely secures the panel on thin cabin roofs or RV roofs. Using a well-nut is recommended, as the rubber expansion prevents water leakage. (The Z-Bracket set does not include well nuts)

Step1: Attach the Z-brackets to the panels

Attach the Z-Bracket to the solar panel by the pre-drilled mounting holes on the back of the solar panel. Solar Panels have two mounting holes on each side.



Step2: Mark and drill holes

With the Z-Brackets attached to the frame, the panel can be laid on a mounting surface, making it easier to mark the holes for the well-nut.

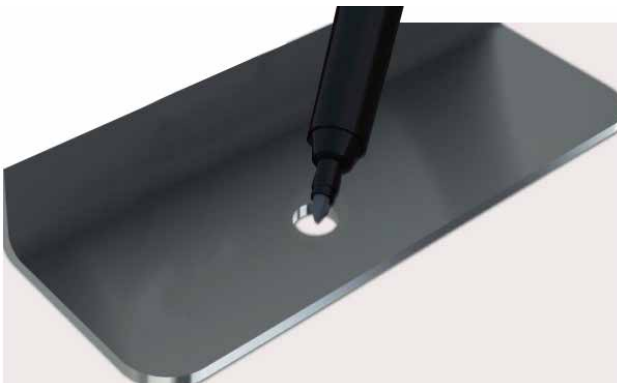

### Step3: Install the panel on the roof

The picture below illustrates the correct way to use the well-nut. The rubber flange has to be flushed on the roofline. The Z-Bracket, along with the flat washer and lock washer, holds the well-nut in place when the screw is fastened.

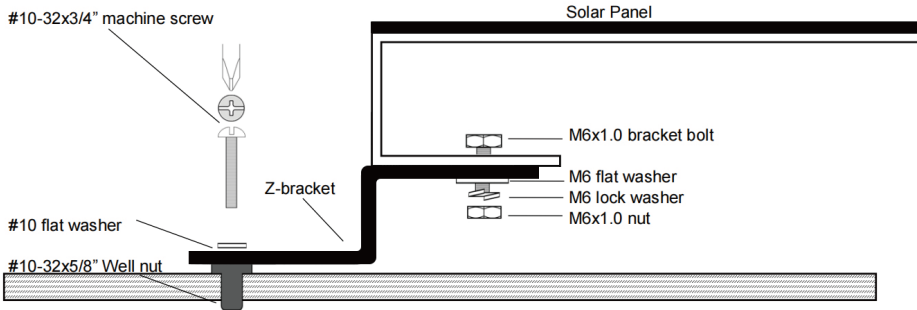

Gently insert the well-nut into the drilled hole. Be careful not to push the well-nut flange completely into the holes. Make sure the flange is flushed on the roofline. Before attaching the panel to the roof, a film of caulk can be laid between the roof and the Z-Bracket. Even though the well-nut provides a watertight bond, this provides additional sealant.

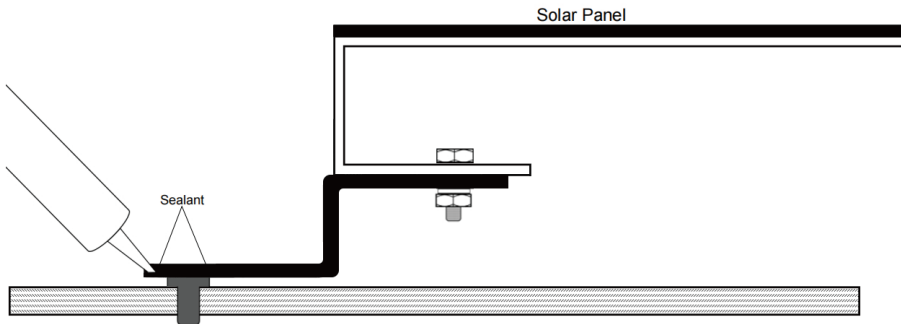

## -Setup the panels array

The hybrid inverter requires 48V input from the solar panels array. So the 20 panels should be wired into a 48V array.

### Wiring method:

1. Connect every 4 panels in series to make a 48V string

Each ECO-WORTHY Solar Panel has a pair of MC4 solar cable at the back of panel that consists of male and female connectors. This type of connector uses a “snap-in” type of safety locking clips to lock the two mating connectors, making it easy to install.

For series connections, just plug one panel’s male and the other’s female MC4 connectors together.



MC4 Connectors and mating contacts



2. Do the same to the other 16 pieces, so there will be 5 groups of 48V 400W solar panels total. Each group has 2 rest wires, one positive and one negative, they are the outlet cables of the string.

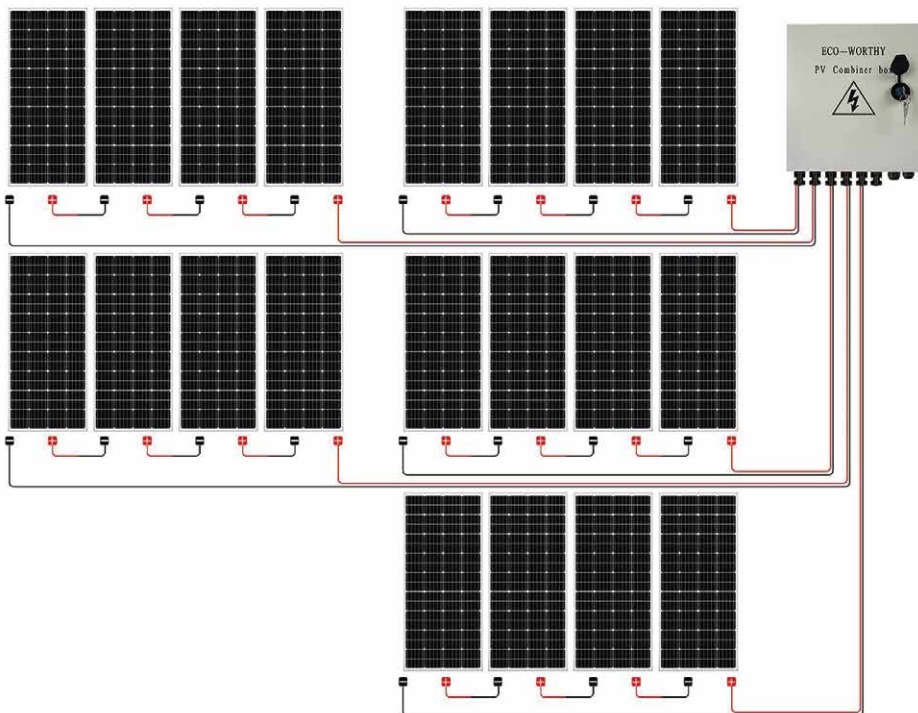

### -Connect solar strings to combiner box

Use each string's outlet cables to wire with the input ports of combiner box. The combiner box has totally 6 string ports, for this system and 5 solar strings, only 5 of them will be occupied.

Connect the 5 solar panel groups to the PV input port of the 6 string pv combiner box



### -PV output to hybrid inverter

After all the solar array cables get arranged into the combiner box, connect the combine box to the hybrid inverter.

Use the 16.ft 8AWG solar-controller cable for the connection. MC4 terminals to plug the combiner box's output port, and the copper terminals to the inverter PV input port.

### -Inverter to mains(Optional)

The hybrid inverter has UPS function, if you need to activate it, just connect the unit to the grid.

There is one AC IN port on the unit's bottom, there's 3 separating ports for grounding, positive, and negative connection. Use one proper cable (at least 8AWG) to connect the positive and negative ports with the grid busbar, just plug the copper terminals into the ports, and tie the screws with a screwdriver.

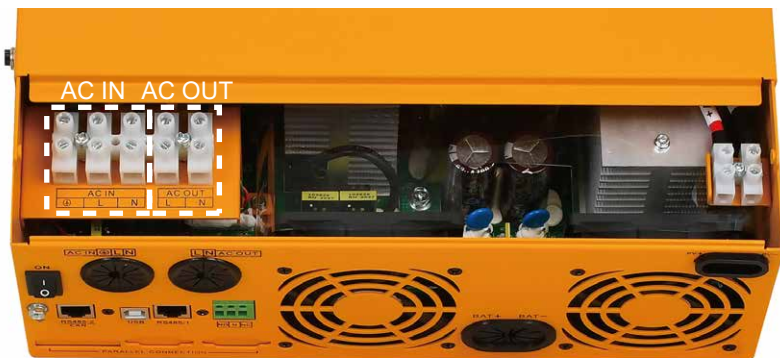

## -Inverter to appliances

Before booting the inverter, the AC OUT ports should be wired with the home socket or appliances first.

Same as the AC IN wiring, you need to prepare one pair of appropriate cable for the ports connection, and just wire the ports with the socket.

## -Turn on the inverter

When all wirings are done, the final step is to boot the hybrid inverter by pressing the switch on its bottom.

(Note: the inverter only works when 48V battery bank connected) There are various icons on the screen, check if the PV, mains, battery, load icons appear. If one icon does not light up, it means this connection to the inverter is not available, so you can have a check on specific item. It's able to change the settings when the display lights on. For more settings detail, you could watch the guide video on Youtube:

<https://youtu.be/juzuTVcrnx8>

<https://youtu.be/4MdElxXspTU>



**EASY MONITORING & SETTING**

The LCD display shows the following menu screens:

- Normal Display: 52.3, 12.0
- Ac Output Frequency Settings: 0.7, 50.0
- Charging Mode: 0.6, 5.0
- Battery Type: 0.8, 5.1d
- Charging Voltage Setting: 1.1, 56.8
- Equalization charging voltage: 1.7, 58.4

The physical control panel includes the following legend:

Indicator	Color	Function
AC/INV	Yellow	Steady on: Mains output Flash: Inverter output
CHARGE	Green	Steady on: Charged completed Flash: Battery charging
FAULT	Red	Steady on: Fault state
SET		Enter/Exit settings menu
UP		Previous choice
DOWN		Next choice
ENT		Confirm/Enter options under the settings menu



# Fusing and Setting

## -Fusing position

The combiner box has built-in fuses for each string, so there is no need to add extra fuse in between the solar panels and combiner box, neither from the combiner box to inverter.

Even though the hybrid inverter has built-in fuse, it's better to add one fuse in between it and the battery bank. For a 48V 3500W inverter, the current it receives from battery should be about 73A, so a 80A fuse is recommended.



## -Grounding

The hybrid inverter has a grounding screw on the unit bottom for grounding.

A grounding rod is required for actually wire the unit with the ground, it could be easily found in local store or Amazon. The installation steps:

1. Press down the grounding rod into the ground for more than 7.6 inch (50cm) depth
2. Wire one copper cable from the grounding screw to the rod (wire gauge should be 1.5 time as the AC output wire)



## Testing and Troubleshooting

### Testing

Test all electrical and electronic components of your system before commissioning it. Follow the instructions in the guides supplied with the components and equipment.

- Test modules connected in series before they are connected to the system.

- To determine  $V_{oc}$  and  $I_{sc}$  in the following tests, the module(s) must be exposed to the sun and not connected to a load. Observe personal safety when making these measurements.

- Check the open-circuit voltage ( $V_{oc}$ ) of every series module using a digital multimeter. The measured system  $V_{oc}$  should correspond to the sum of the  $V_{ocs}$  of the individual module. You will find the rated voltage in the technical specifications of the specific module. If the measured value is significantly lower than the expected value, proceed as described under “Troubleshooting an low voltage”.

- Determine the short-circuit current ( $I_{sc}$ ) of every series circuit. It can be measured directly by connecting the digital multimeter to the two terminals of the series circuit or module. Attention, the rated scale of the ammeter or the rated current of load should be more than 1.25 times of the rated short-circuit current of the series module. You will find the rated current data in the technical specifications sheet. The measured value can vary significantly, depending on weather conditions, the time of day, and the shading of the module.

## Troubleshooting a low voltage

To identify the commonly low voltage and excessively low voltage, the commonly low voltage mentioned here is the decrease of open-circuit voltage of the module, which is caused by the temperature rising of solar cells or lower irradiance. Excessively low voltage is typically caused by improper connections of the terminals or defective bypass diodes.

- First, check all wiring connections to see if it is not open-circuit or is not connected well.
- Check the open-circuit voltage of each module
- Disconnect the wiring at both terminals of the modules.
- If the measured voltage is only half of the rate, this indicates a defective bypass diode. By replacing or remove the diode, the issue may be sorted. Removing the bypass diodes should only be done by a competent PV technician and the module has to be disconnected from the system.

In the case of fine irradiance, if the voltage across the terminals differs from the rated value by more than 15%, this indicates a bad electrical connection.

## FAQ

A1:The hybrid inverter is not working. The screen is not showing anything.

Q1:For this situation, there are 3 things to check:

- (1) Check for loose, broken or corroded connections in the cables between the inverter and battery bank.
- (2) Check the fuses/breakers in the combiner box.
- (3) Verify battery voltage is sufficient to power up the inverter

A2:Everything is hooked up correctly. The sun is shining directly onto the solar panels but no charge is going to the batteries.

Q2:Check the voltage of the battery bank. The battery bank is most likely fully charged and the solar charge controller inside the hybrid inverter has disconnected the solar panels from the battery. The solar charge controller will reconnect the solar panels to the battery bank when it requires charging.

## Maintenance

The following maintenance is recommended to ensure optimum performance and longevity of the solar panel:

- Clean the glass surface of the solar panel when necessary. Always use water and a soft sponge or cloth for cleaning. A mild, non-abrasive cleaning agent can be used to remove dirt.
- Check the electrical and mechanical connections every six months to verify that they are clean, secure and undamaged.
- Inspect the solar panels and make sure the surfaces are free from dust, dirt, and other debris; clean with a wet cloth or glass cleaner if necessary.
- Check to make sure all structural components, mechanical fasteners, and electrical connections are secure, clean, and corrosion-free.
- Check and replace damaged components if necessary

## Support

For the use of this manual and the conditions or methods of installation, operation, use, and maintenance of photovoltaic (PV) product are beyond ECO-WORTHY's control, ECO-WORTHY does not accept responsibility and expressly disclaims liability for any loss, damage, or expense arising out of or in any way connected with such installation, operation, use or maintenance.

No responsibility is assumed by ECO-WORTHY for any infringement of patents or other rights of third parties, which may result from the use of the PV product. No license is granted by implication or otherwise under any patent or patent rights. The information in this manual is based on ECO-WORTHY's knowledge and experience and is believed to be reliable, but such information including product specification (without limitations) and suggestions do not constitute a warranty, expresses or implied.

ECO-WORTHY reserves the right to change the manual, the PV products, the specifications, or product information sheets without prior notice.

This product is covered by a 1 year warranty provided by ECO-WORTHY Ltd. We will refund or partial refund or replace any products with defects due to our imprudence.

If you are experiencing technical problems and cannot find a solution in this manual, please contact ECO-WORTHY for further assistance.

**Contact number:**

US 1-866-939-8222

UK +44 20 7570 0328

Email: [customer.service@eco-worthy.com](mailto:customer.service@eco-worthy.com)